

Stahl-Umfassungszarge Typ TTUDS auf MBW oder LBW, aus 1.5 mm elektrolytisch verzinktem Stahlblech, Ecken auf Gehrung.

El₂ 30

Brandschutz-Tür VFH/40(.A), Ausführungen:	
VKF Nr. 27087	1-flg., ohne/mit Alu, ohne Glas

gezeichnet: Bandseite = links

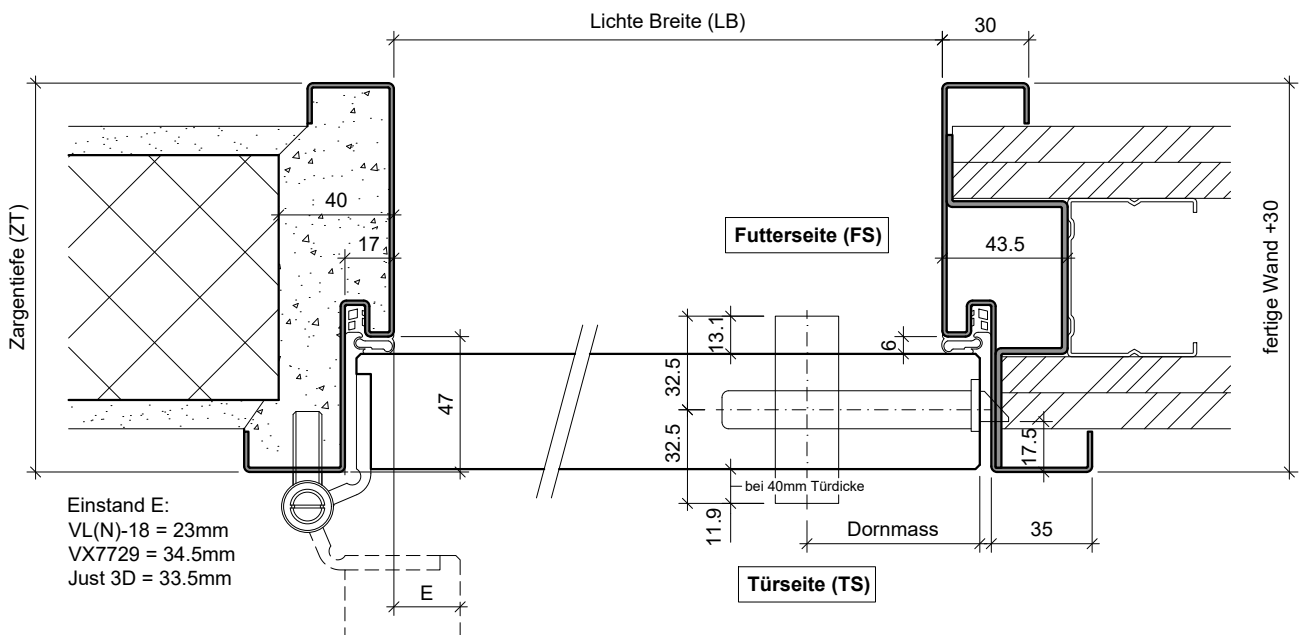
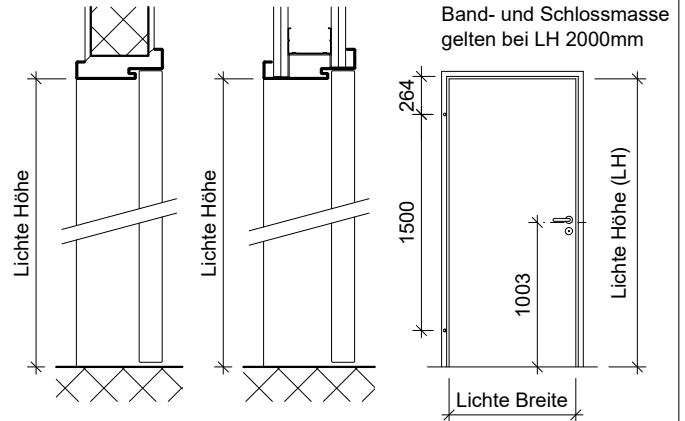

Einstand E:
 VL(N)-18 = 23mm
 VX7729 = 34.5mm
 Just 3D = 33.5mm

Typ: S
(Schwellenwinkel)

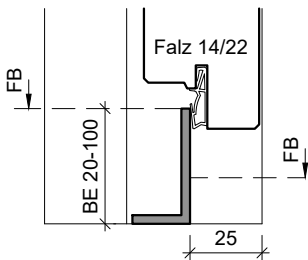

Typ: S
(Schwellenwinkel)

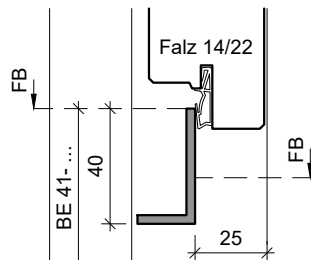

Typ: S+S
(Doppelschwelle)

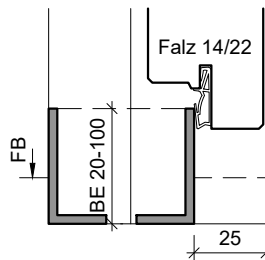

Typ: S+S
(Doppelschwelle)

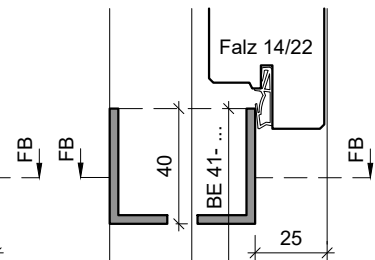

Typ: S (auf FS)
(Konterschwelle)

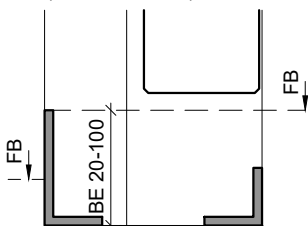

Typ: S (auf FS)
(Konterschwelle)

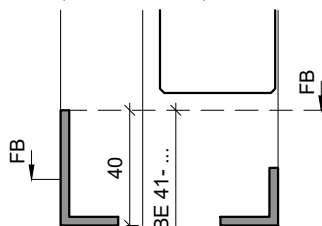

Typ: V
(Verbindungseisen)

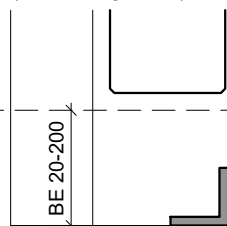

Typ: VP
(prov. Verbindungseisen)

