

	B1 + S1	B1 + S2	B2 + S1	B2 + S2
Schienenlänge	2 x LB + 78	2 x LB + 78	2 x LB + 78	2 x LB + 78
Blendenlänge	2 x LB + 118	2 x LB + 81	2 x LB + 100	2 x LB + 63
Türblattbreite TB	LB + 55	LB + 55	LB + 55	LB + 55

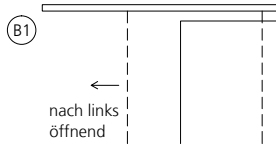

Bandseite, Detail (B1)

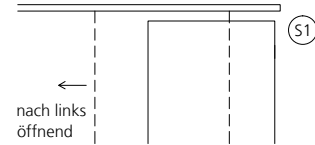
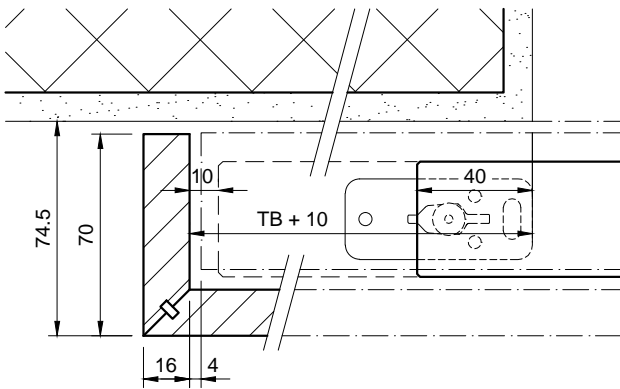

Schlossseite, Detail (S1)

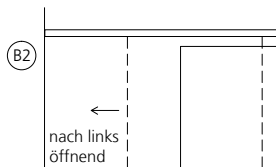
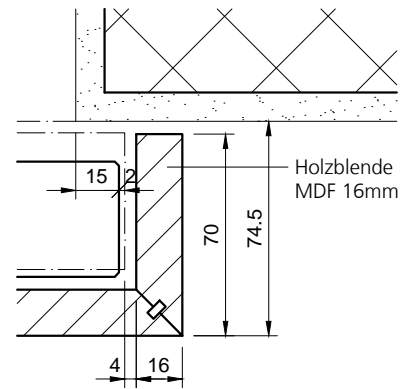

Maueranschlag, Detail (B2)

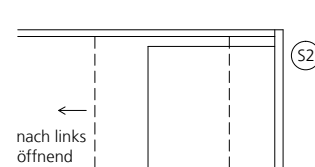
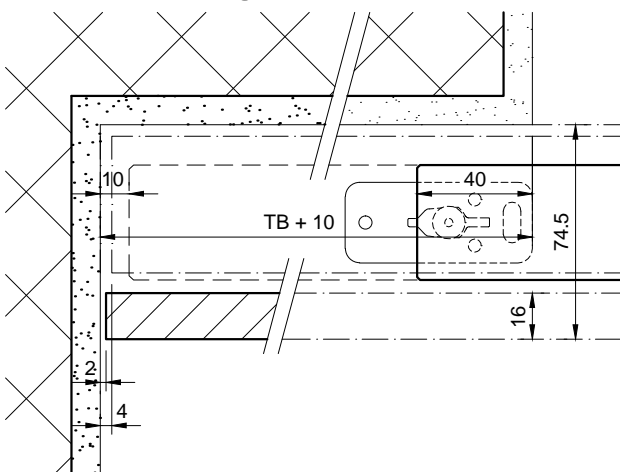

mit Einlaufbalken, Detail (S2)

